

Elektro- und
Hydraulikanschluß

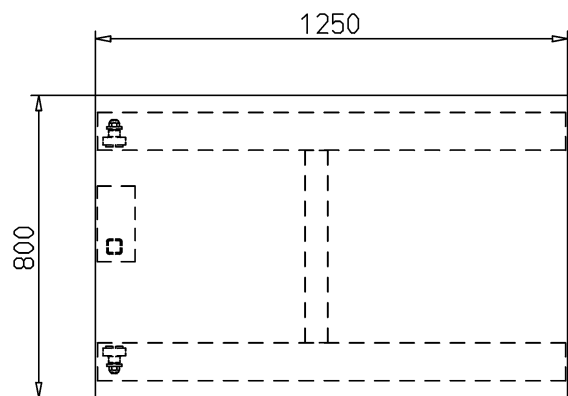

Oberrahmen
Deckblech t=8

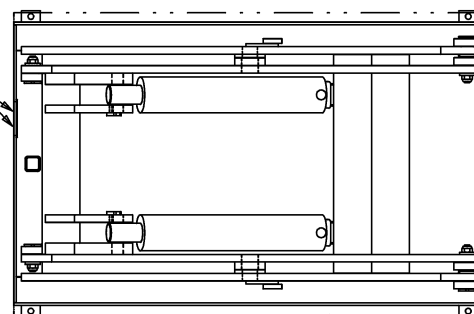
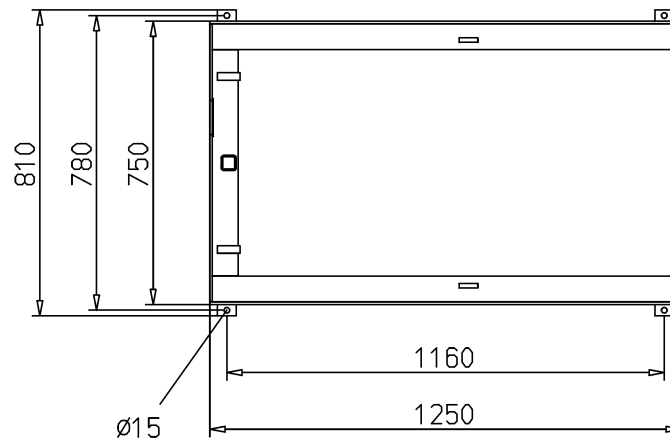

Unterrahmen
nicht selbsttragend!

Aggregat außerhalb an 2m Schlauch!
Abmessungen ca.: lxbxh 730x550x250

Maßblatt ELD 3-16-1