

Elektro- und
Hydraulikanschluß

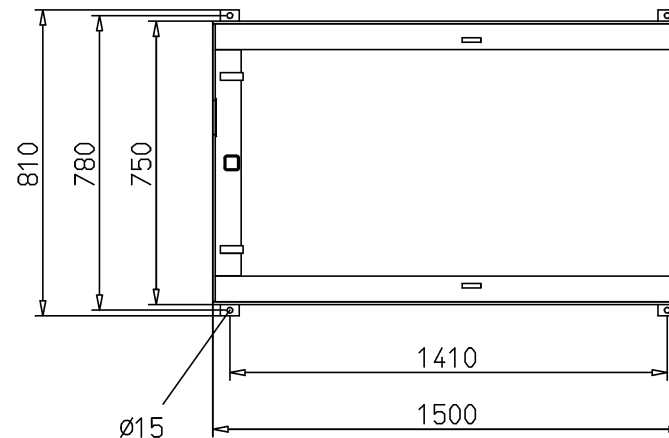
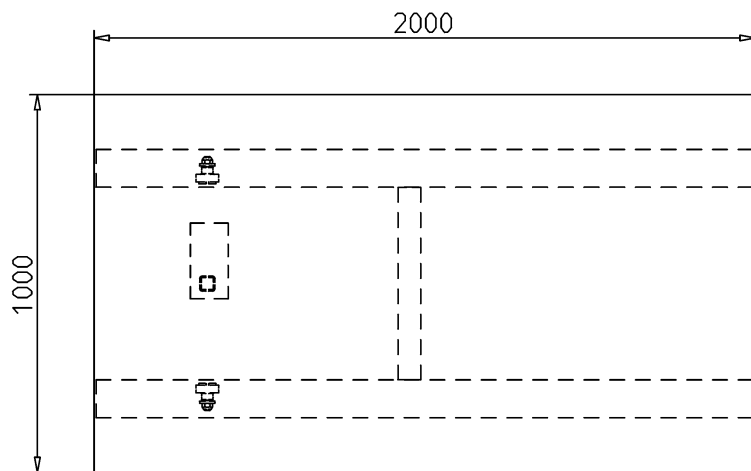
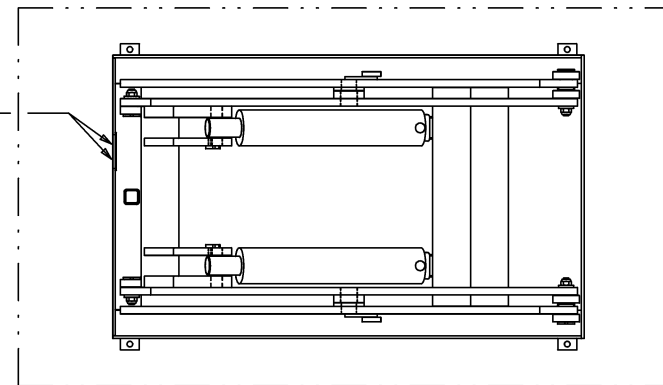

Unterrahmen
nicht selbsttragend!

Aggregat außerhalb an 2m Schlauch!
Abmessungen ca.: lxbxh 730x550x250

Oberrahmen
Deckblech t=8

Maßblatt ELD 3-18-9