

Elektro- und
Hydraulikanschluß

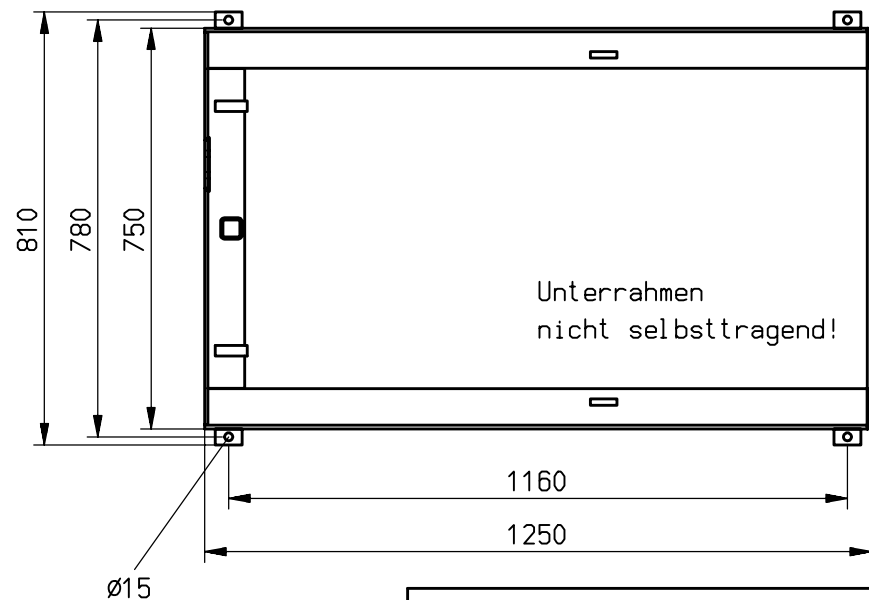
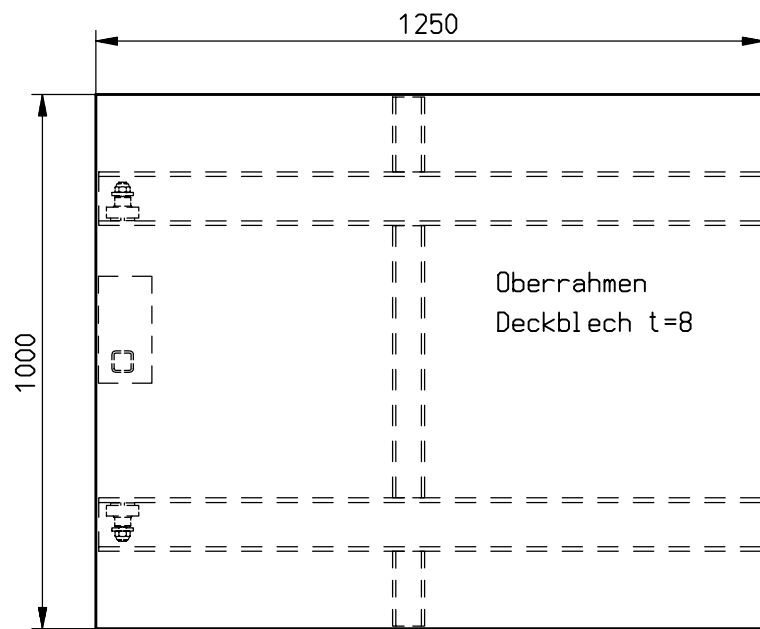
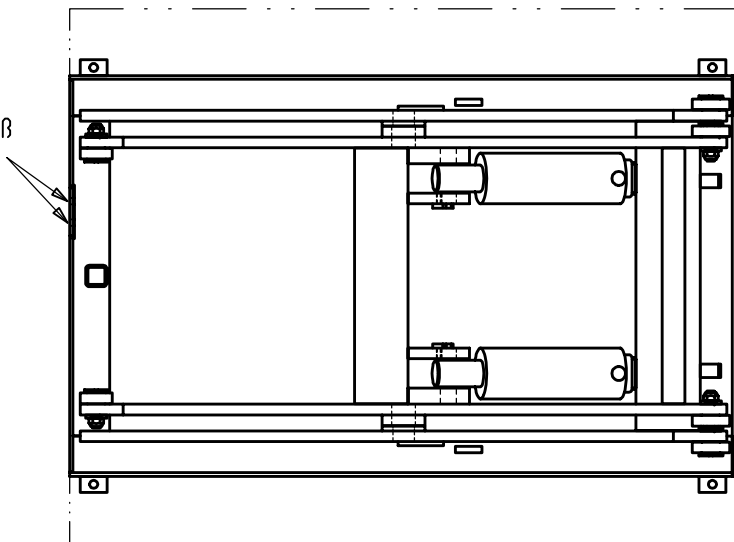

Aggregat außerhalb an 2m Schlauch!
Abmessungen ca.: lxbxh 550x500x200

Maßblatt ELS 3-8-2