

Elektro- und
Hydraulikanschluß

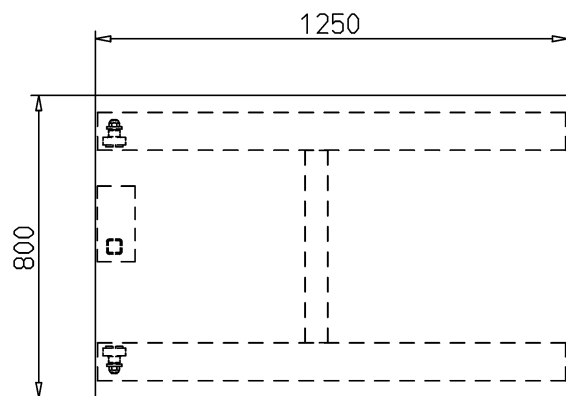

Oberrahmen
Deckblech t=5

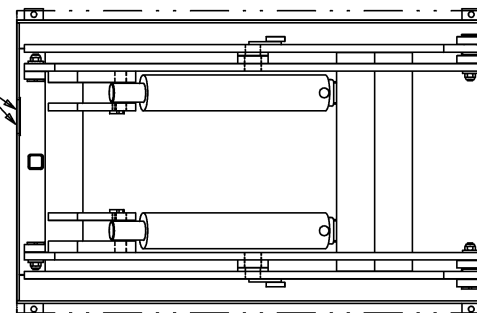
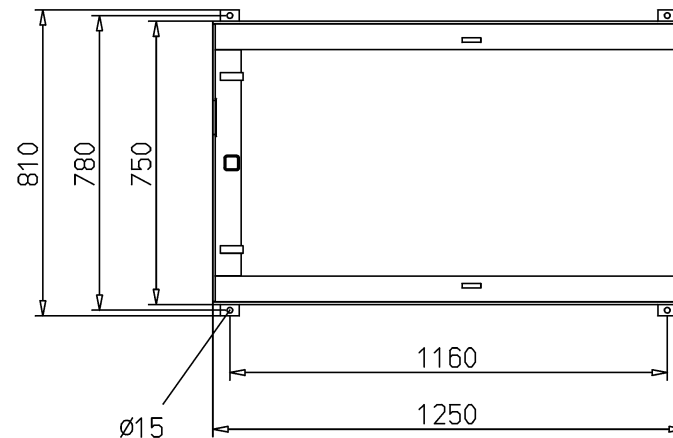

Unterrahmen
nicht selbsttragend!

Aggregat außerhalb an 2m Schlauch!
Abmessungen ca.: lxbxh 600x550x200

Maßblatt ELD 2-16-1