

Elektro- und
Hydraulikanschluß

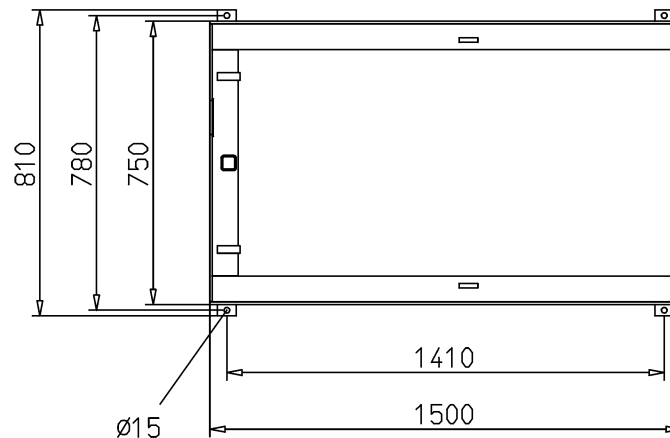
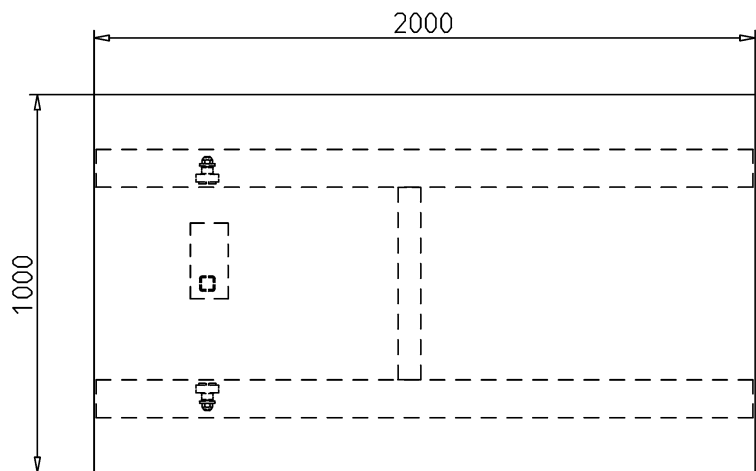
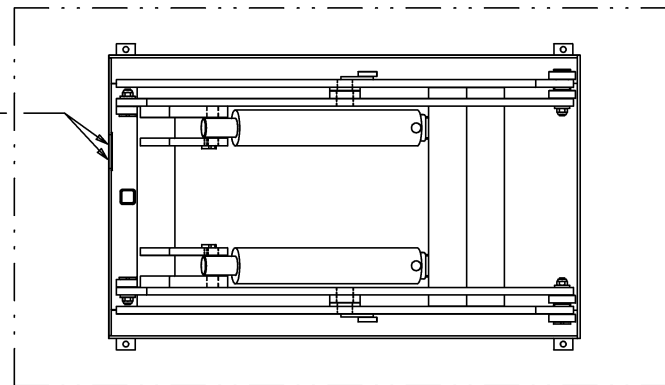

Unterrahmen
nicht selbsttragend!

Aggregat außerhalb an 2m Schlauch!
Abmessungen ca.: lxbxh 900x550x250

Oberrahmen
Deckblech t=10

Maßblatt ELD 4-18-9