

Elektro- und
Hydraulikanschluß

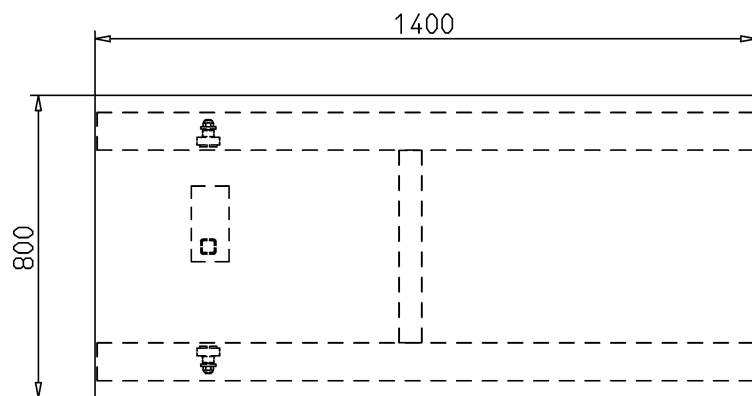

Oberrahmen
Deckblech t=10

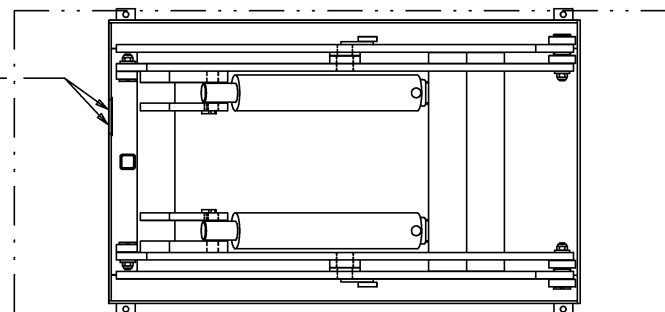
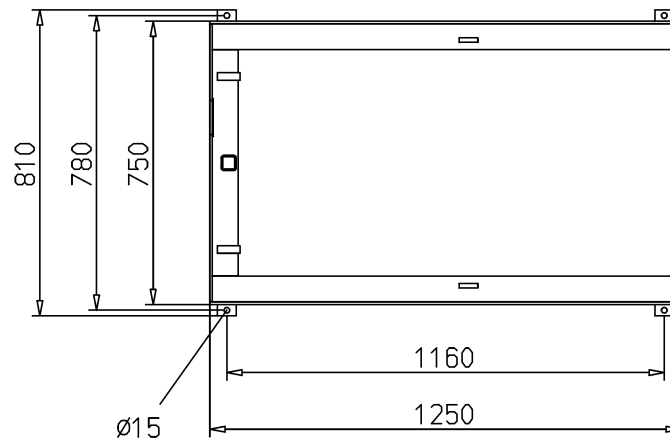

Unterrahmen
nicht selbsttragend!

Aggregat außerhalb an 2m Schlauch!
Abmessungen ca.: lxbxh 600x700x250

Maßblatt ELD 5-16-3