

E-Anschluß

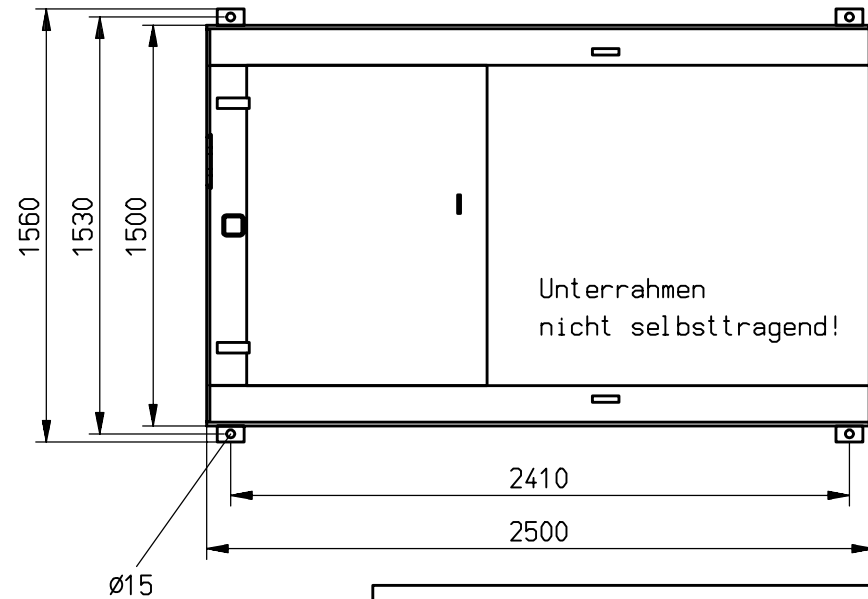
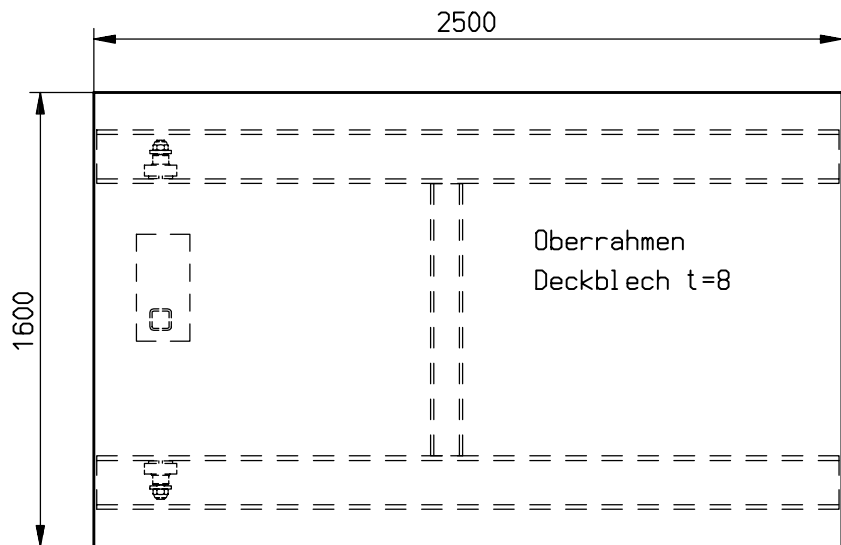
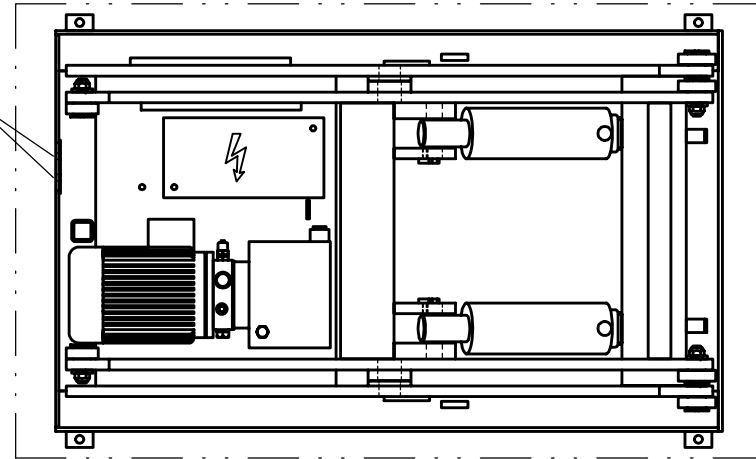

Maßblatt ELS 1-16-18