

E-Anschluß

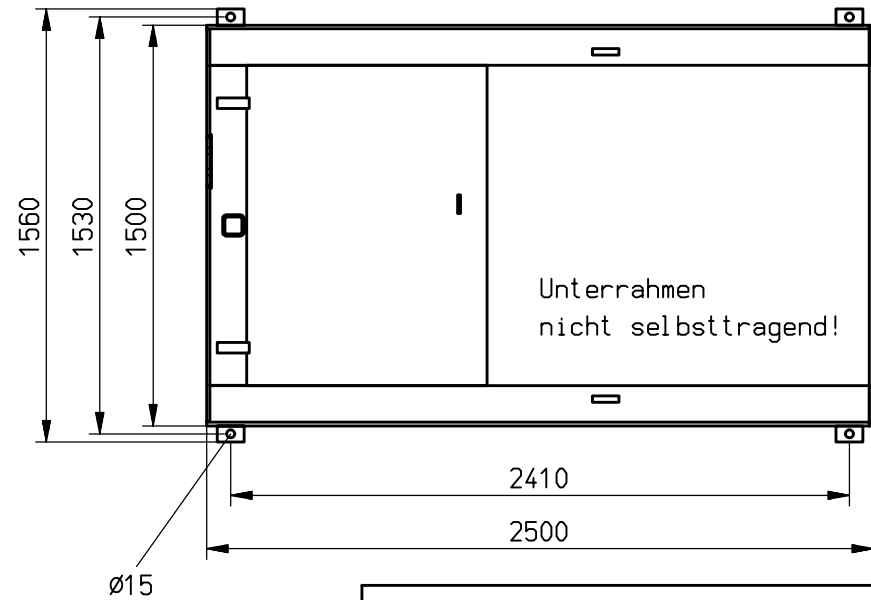
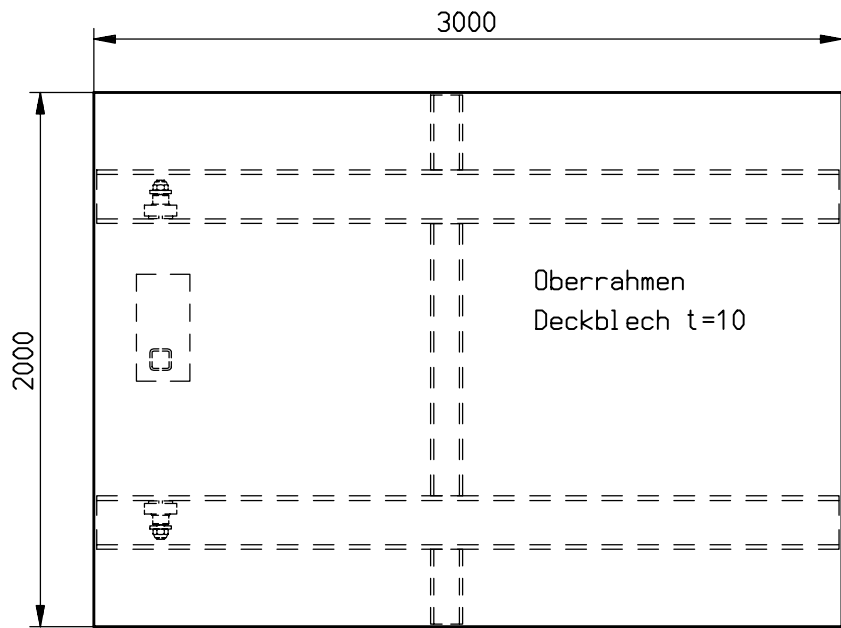
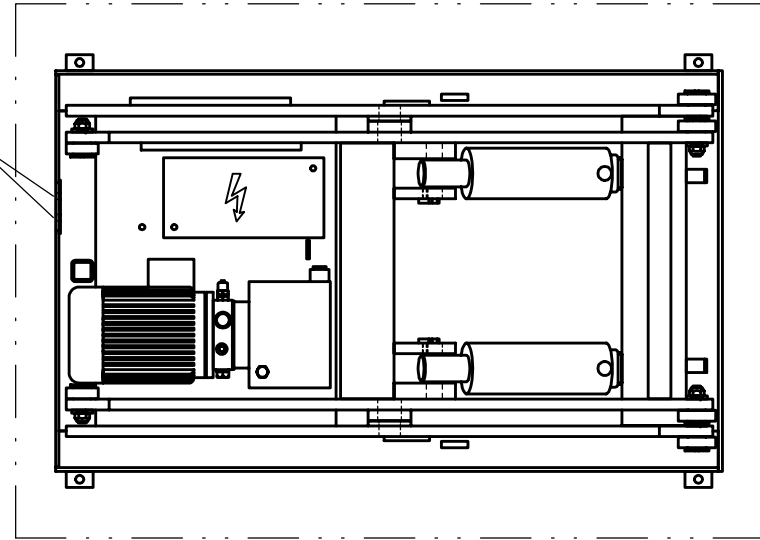

Maßblatt ELS 4-16-19