

Elektro- und  
Hydraulikanschluß

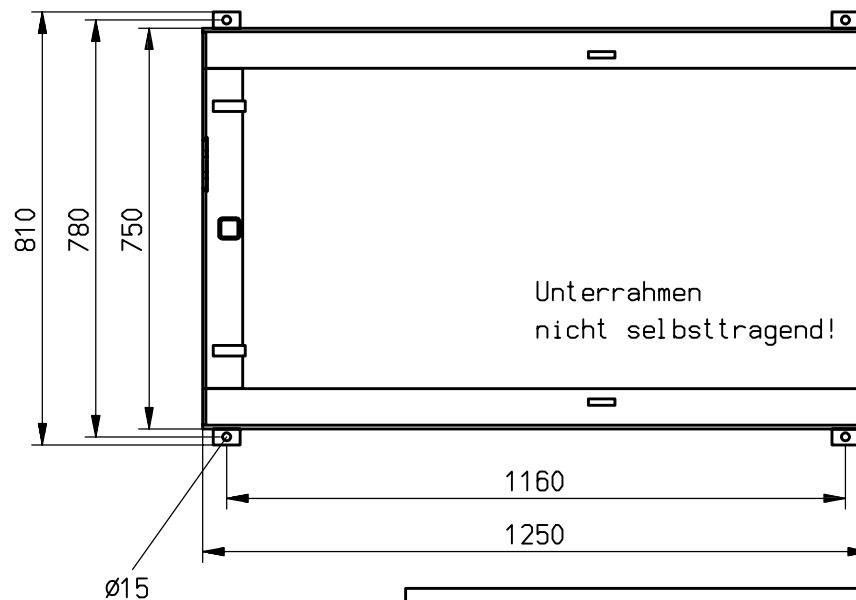
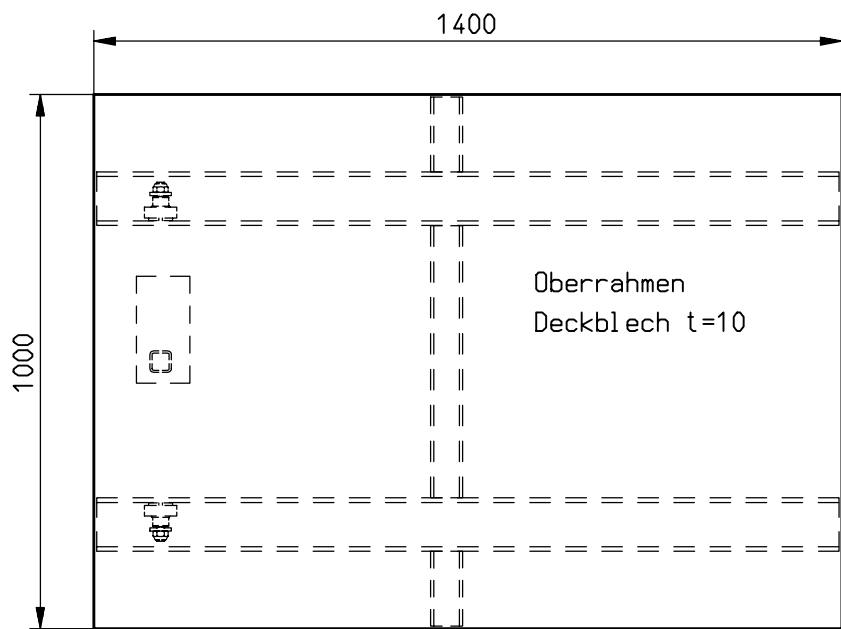
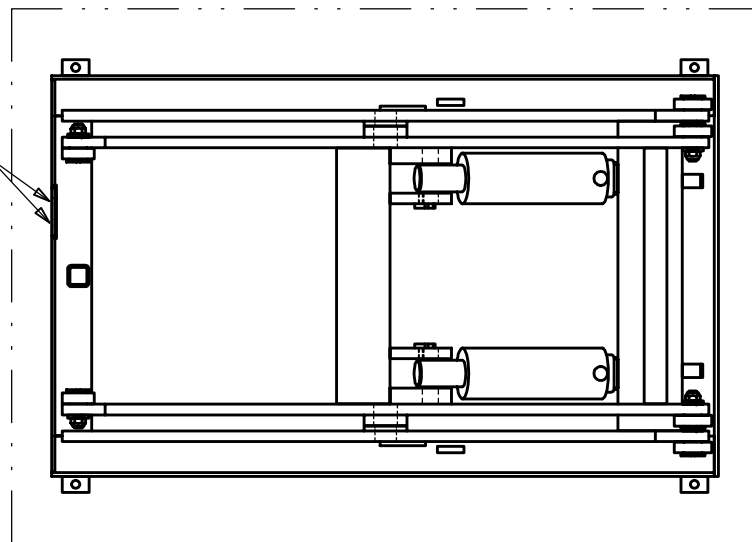

Aggregat außerhalb an 2m Schlauch!  
Abmessungen ca.: lxbxh 730x550x250

Maßblatt ELS 4-8-4